



Product Service Manual For A4PIC Series Pumps

WARNING

<p>This Special Instruction Manual and General Instructions Manual, SRM00046, should be read thoroughly prior to pump installation, operation or maintenance.</p>
--

SRM00079	Rev. 01 (21-0001)	October, 2021
----------	-------------------	---------------



READ THIS ENTIRE PAGE BEFORE PROCEEDING

FOR THE SAFETY OF PERSONNEL AND TO PREVENT DAMAGE TO THE EQUIPMENT, THE FOLLOWING NOMENCLATURE HAS BEEN USED IN THIS MANUAL:

	DANGER	
Failure to observe the precautions noted in this box can result in severe bodily injury or loss of life.		

	WARNING	
Failure to observe the precautions noted in this box can cause injury to personnel by accidental contact with the equipment or liquids. Protection should be provided by the user to prevent accidental contact.		

	CAUTION		ATTENTION
Failure to observe the precautions noted in this box can cause damage or failure of the equipment.			

Non compliance of safety instructions identified by the following symbol could affect safety for persons: 	Safety instructions where electrical safety is involved are identified by: 	Safety instructions which shall be considered for reasons of safe operation of the pump and/or protection of the pump itself are marked by the sign: <div style="border: 1px solid black; display: inline-block; padding: 2px 5px;">ATTENTION</div>
--	---	---

CONTENTS

Safety and Table of Contents	A
A. General Instructions	1
B. Introduction and Pump Model Identification.....	1
C. Description of Pump.....	1
D. Ordering Instructions.....	1
E. Operating and Maintenance.....	1
F. Parts List and Torque Tables	2
G. Inspection	2
H. Pump Maintenance (Disassembly and Assembly Instructions).....	3 - 4
I. Pump Assembly Drawing.....	5

ATTENTION
<p><i>If operation of this pump is critical to your business, we strongly recommend you keep a spare pump or major repair kit in stock at all times. As a minimum, a minor repair kit (o-rings, gaskets, shaft seal and bearings) should be kept in stock so pump refurbishment after internal inspection can be accomplished.</i></p>

A. GENERAL INSTRUCTIONS

The instructions found herein cover the disassembly, assembly and parts identification of A4PIC series pumps.

NOTE: Individual contracts may have specific provisions that vary from this manual. For further detailed information and technical assistance to questions not answered by these manuals, please refer to Imo Pump, Technical/Customer Service Department, at (704) 289-6511.

This manual cannot possibly cover every situation connected with the installation, operation, inspection, and maintenance of the equipment supplied. Every effort was made to prepare the text of the manual so that engineering and design data is transformed into the most easily understood wording. Imo Pump must assume the personnel assigned to operate and maintain the supplied equipment and apply this instruction manual have sufficient technical knowledge and experience to apply sound safety and operational practices which may not be otherwise covered by this manual.



WARNING

If installation, operation and maintenance instructions are not correctly and strictly followed and observed, injury to personnel or serious damage to pump could result. Imo Pump cannot accept responsibility for unsatisfactory performance or damage resulting from failure to comply with instructions.

B. INTRODUCTION

This instruction manual covers series A4PIC Imo pumps. This series of pumps has been designed for use in hydraulic elevator submerged applications. The model, construction and material of each pump is identified on the pump nameplate. Definitions of model designators are identified in Figure 1.

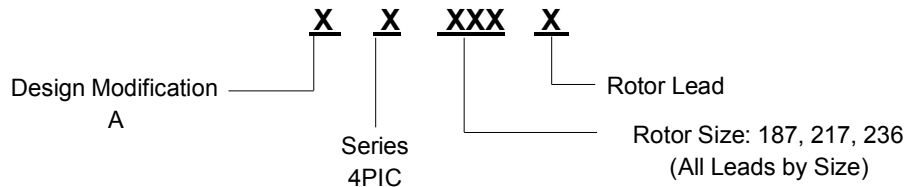

Figure 1 – Definition of Model Designators

C. DESCRIPTION OF PUMP

The 4PIC series pumps are positive displacement, rotary screw pumps consisting of a precision bored housing that encloses a driven screw (power rotor) and two intermeshing following screws (idler rotors). These screws when rotating form a succession of closures or cavities. As they rotate, the fluid is moved axially from the inlet to the outlet port in a continuous, uniform flow with minimum fluid pulsation and pump noise.

D. ORDERING INSTRUCTIONS

To order a replacement pump, contact Imo service representative with the pump model number, serial number and manufactured date. This information can be found on the pump's nameplate.

E. OPERATION

E.1 LIQUID LIMITATIONS

Never operate with thin liquids such as solvents or water. The pump is designed for liquids having the general characteristics of oil.

E.2 OPERATING LIMITATIONS

CAUTION	ATTENTION
<p>Operating conditions, such as speed, fluid viscosity, temperature inlet pressure, discharge pressure, filtration, duty cycle, drive type, mounting, etc., are interrelated. Due to these variable conditions, the specific application limits may be different from that of the operational limitations. This equipment must not be operated without verifying the system's operating requirements are within the pump's capabilities.</p>	

Under no circumstances are the operating limits (specified in Table 1 below) to be exceeded without specific approval from Imo Pump.

Table 1 – Pump Operating and Structural Limits

MAXIMUM SPEED 3600 RPM
VISCOSITY 60 SSU (10.3 cSt) Minimum, if over 5000 SSU (1079 cSt) contact Imo Pump

NOTE: Consult factory for allowable operating viscosity at specific speeds and pressures.
DO NOT alter design viscosity without prior consultation with Imo Pump

TEMPERATURE 0° to 180° F (-18° to 82° C) Maximum
INLET PRESSURES 4PIC Pump types must be submerged to a depth of at least 6 in. (15.24 cm) from top of pump to top of fluid
DISCHARGE PRESSURE* See Elevator Pump Data Book
DRIVE Direct drive only
FILTRATION Always use inlet strainer supplied with pump
MOUNTING Flange mounted

F. PARTS LIST AND TORQUE TABLES

Table 2 – Pump Parts List

IDP	QTY	DESCRIPTION	IDP	QTY	DESCRIPTION
1	1	Power Rotor	10	2	SCHS DIN 912 M10 x 1.5 x 35 mm NYLO
2	1	Key	11	2	Idler Rotor(s)
3	1	Retaining Ring	12	1	Supporting Washer
4	1	Circlip	15	1	Strainer
5	1	Bearing	17	4	Hex Bolt(s)
6	1	Inboard Cover	20	1	Adapter
8	1	Rotor Housing	21	2	#4 Drive Screw
9	4	Lockwasher(s)	22	2	Nameplate

Table 3 – Fastener Descriptions and Torque Tightening Values

PUMP	IDP	DESCRIPTION	TORQUE (English)	TORQUE (Metric)
PIC 187	10	Cap Screw	35 ± 2 Ft. Lb.	47 ± 3 Nm
	17	Hex Bolt	100 ± 5 lb. in.	12 ± 3 Nm
	20	Adapter	75 ± 7 Ft. lb.	101 ± 3 Nm
PIC 217	10	Hex Bolt	35 ± 2 Ft. Lb.	47 ± 3 Nm
	17	Hex Bolt	100 ± 5 lb. in.	12 ± 3 Nm
	20	Adapter	95 ± 9 Ft. lb.	129 ± 3 Nm
PIC 236	10	Hex Bolt	35 ± 2 Ft. Lb.	47 ± 3 Nm
	17	Hex Bolt	100 ± 5 lb. in.	12 ± 3 Nm
	20	Adapter	95 ± 9 Ft. Lb.	129 ± 3 Nm

G. INSPECTION

The interval for inspection and replacement of worn parts varies with the properties of the pumped liquid and can only be determined by experience. All parts of the 3SIC and 4SIC series pumps are lubricated by the pumped fluids. Pumping liquid which contains abrasive materials or liquid that is corrosive, will significantly reduce service life and call for shorter service intervals. A worn pump will be noticeable by excessive vibration, noise, reduction in flow or reduction in pressure.

H. PUMP MAINTENANCE



WARNING

Failure to observe precautions while installing, inspecting, and maintaining the pump can cause injury to personnel from accidental handling, e.g.: Liquids that may harm skin or clothing, fire hazard risks from flammable liquids, or injury from high pressure fluid jets.



DANGER

BEFORE working on equipment, be sure all power to the equipment is disconnected and locked-out.

H.1 GENERAL COMMENTS

- Part number identifiers (IDPs) contained within parenthesis such as (8) refer to the circled numbers shown on Assembly Drawings, Figures 2 and 3.
- Close all pump line valves.

H.2 TOOLS REQUIRED

The procedures described in this manual require common mechanics hand tools, a torque wrench and a suitable lifting device (such as) slings, straps, etc.

H.3 PUMP DISASSEMBLY

CAUTION

ATTENTION

Fluid leakage from disassembly of pump may make the floor slippery and cause personal injury.

NOTE: The 4PIC pumps incorporate highly finished precision parts that must be handled carefully to avoid damage to critical machined surfaces. The parts removed should be tagged for identification and their exact positions in the pump carefully noted so that new parts, or the removed parts, are properly replaced.

STEP 1. Remove Pump from Driver.

Remove bolts (17) and washers (9).

Slide pump out and away from driver. Place pump on workbench.

If replacing bearing, remove key (2) from power rotor (1) shaft keyway.

STEP 2. Remove Strainer (suction side).

Remove strainer retaining ring (3) and strainer (15)

Step 3. Remove Front cover and Rotor Set as a sub-assembly.

Use caution when removing front cover from the pump housing.

Pump should be placed on end (suction side down) on a solid flat surface when performing this step.

During this step it is important to hold the idler rotors against the power rotor until the entire sub-assembly can be placed on the work bench.

a) Remove cap screws (10).

b) Lift the front cover (6) with power rotor (1), idler rotors (11), ball bearing (5), supporting washer (12) and circlip (4) from the housing. During removal, it is necessary to hold the idler rotors (11) against the power rotor (1) until the sub-assembly is placed on the work bench. At that time, the idler rotor (11) can be disengaged from the power rotor (1).

NOTE: The ball bearing (5) should be replaced if it is pressed off the power rotor.

- Step 4. Disassemble front cover, power rotor, bearing, circlip and support washer sub-assembly.
- a) Remove circlip (4) from front cover (6).
 - b) Remove support washer (12) from the power rotor.
 - c) Slide front cover (6) down and off of the power rotor (1).
 - d) Remove ball bearing (5) from the power rotor.

H.4 PUMP ASSEMBLY

NOTE: Prior to pump assembly, all parts should be cleaned and inspected for nicks, burrs or gouges.
When ready for assembly, wipe all parts, including bolts, with SAE 30 lubricating oil.

NOTE: When performing Step 1, press only on bearing inner race when installing bearing if bearing is being pressed on. If bearing is being heated for installation, heat to 180°F - 200°F, for installation.

STEP 1. Install bearing onto power rotor.
Press or shrink fit bearing (5) onto power rotor (1).

STEP 2. Install front cover.
Slide front cover (6) cover and up onto power rotor (1), until bearing (5) is seated in the bearing bore of cover (6).

STEP 3. Install supporting washer.
Install supporting washer (12) onto power rotor (1) against inner race of bearing (5).

STEP 4. Install circlip.
Install circlip (4) into groove at coupling side of circlip (4) on power rotor (1).

NOTE: Use caution when removing front cover from the pump housing.
Pump should be placed on end (suction side down) on a solid flat surface when performing this step.
During this step it is important to hold the idler rotors against the power rotor until the entire sub-assembly is positioned with a minimum of the rotor set length into the housing. This is to ensure that the idler rotors won't disengage from the power rotor.

STEP 5. Install front cover, power rotor, idle rotors, circlip and supporting washer sub-assembly into the housing.

- a) Carefully mesh the idler rotors (11) in proper position axially onto the power rotor (1). While holding the idler rotors (11) in position against power rotor (1), carefully lift the rotor set, front cover sub-assembly and install into housing (8). When the rotor set is approximately 50% of its length into housing (8), you can release idler rotors (11) and continue installation until front cover (6) is firmly seated on the locating diameter of housing (8).
- b) Install and torque cap screws (10) to required torque per Table 3, locking front cover and rotor set sub-assembly into position on housing (8).

STEP 6. Install strainer.
Lay pump on its side. Install strainer (15) into position in housing (8). Install retaining ring (3) into position in housing (8).

STEP 7. Install adapter.
If adapter (20) was removed, screw into place on housing (8) and torque to required value per Table 3.
Pump should rotate free and smooth 360° of rotation.

STEP 8. Install pump into system.
Pump may now be installed into the system, install lock washers (4) and bolts (17). Torque bolts (17) in accordance with Table 3.

The pump may now be operated in the normal manner.

I. PUMP ASSEMBLY DRAWING

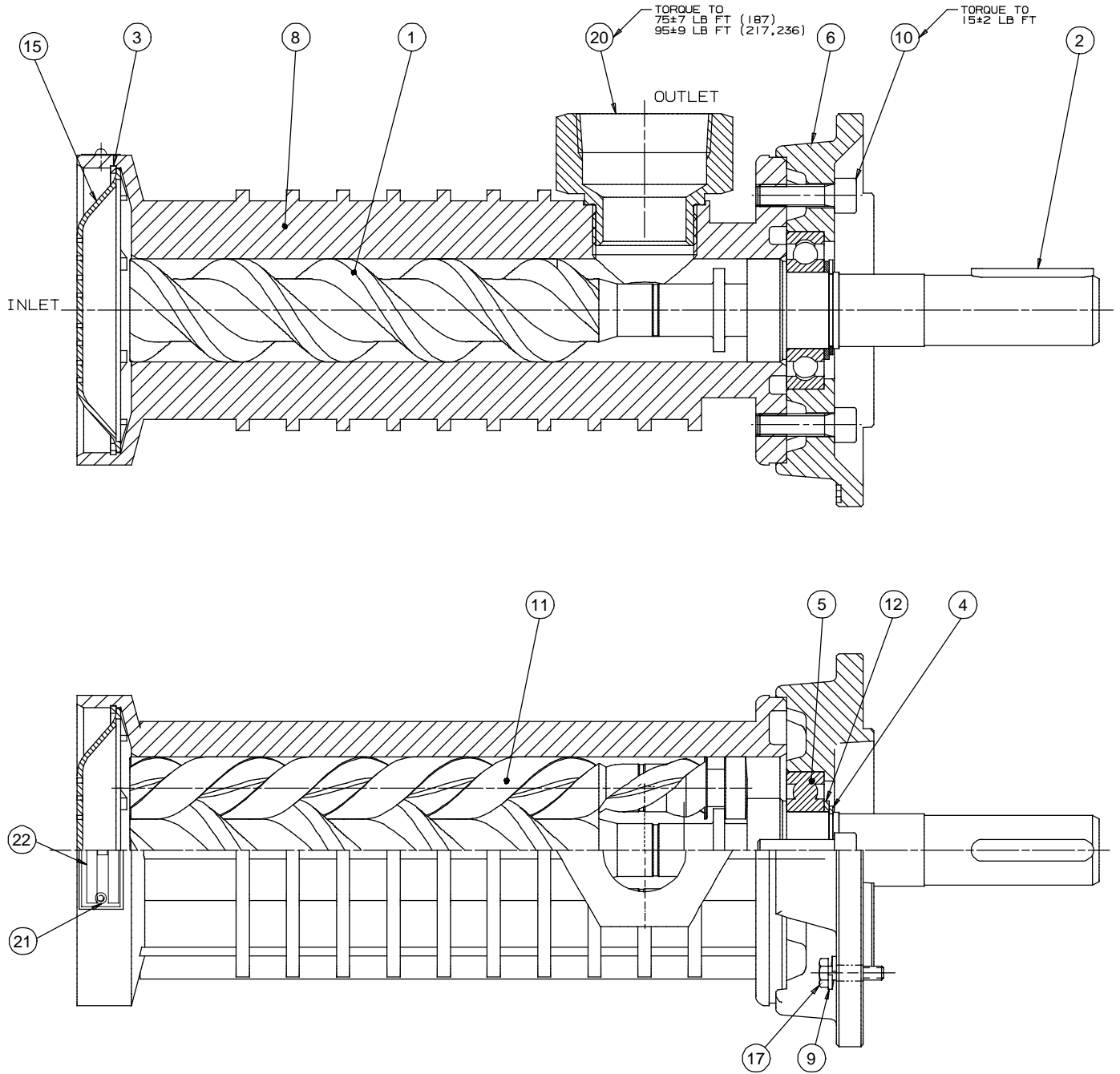
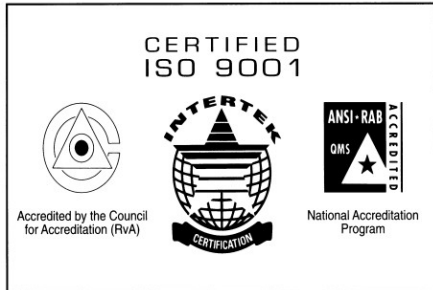

Figure 3 – Assembly Drawing SF 6349

IDP	DESCRIPTION
1	Power Rotor
2	Key
3	Retaining Ring
4	Circlip
5	Bearing
6	Inboard Cover
8	Rotor Housing
9	Lockwasher(s)

IDP	DESCRIPTION
10	SCHS DIN 912 M10 x 1.5 x 35 mm NYLO
11	Idler Rotor(s)
12	Supporting Washer
15	Strainer
17	Hex Bolt(s)
20	Adapter
21	#4 Drive Screw
22	Nameplate



CIRCOR

1710 Airport Road
PO Box 5020
Monroe, NC USA
28111.5020

Tel: +1. 877.853.7867

Email: cc@circor.com

Web: www.circorpt.com

